



**INSTALLATION OF THE
INTERFACE UNIT V4
(INTERNAL)
ROAD VERSION**

WARNING!

Always wear protective gloves and glasses while working on the bicycle.



INSTALLATION OF THE INTERFACE UNIT V4 (INTERNAL)

THIS TECHNICAL MANUAL IS INTENDED FOR USE BY PROFESSIONAL MECHANICS.

Anyone who is not a qualified professional for bicycle assembly must not attempt to install and operate on the components independently due to the risk of carrying out incorrect operations which could cause the components to malfunction, resulting in accidents, physical injury or even death.

The actual product may differ from what is illustrated, as the specific purpose of these instructions is to explain the procedures for using the component.



1 - COMPATIBILITY

ERGOPOWER 12S CONTROLS EPS	12S REAR DERAILLEUR EPS	12S FRONT DERAILLEUR EPS	POWER UNIT V4 EPS
			

2 - INTERFACE WITH THE FRAME

2.1 - SPECIFICATIONS FOR FRAME INSTALLATION

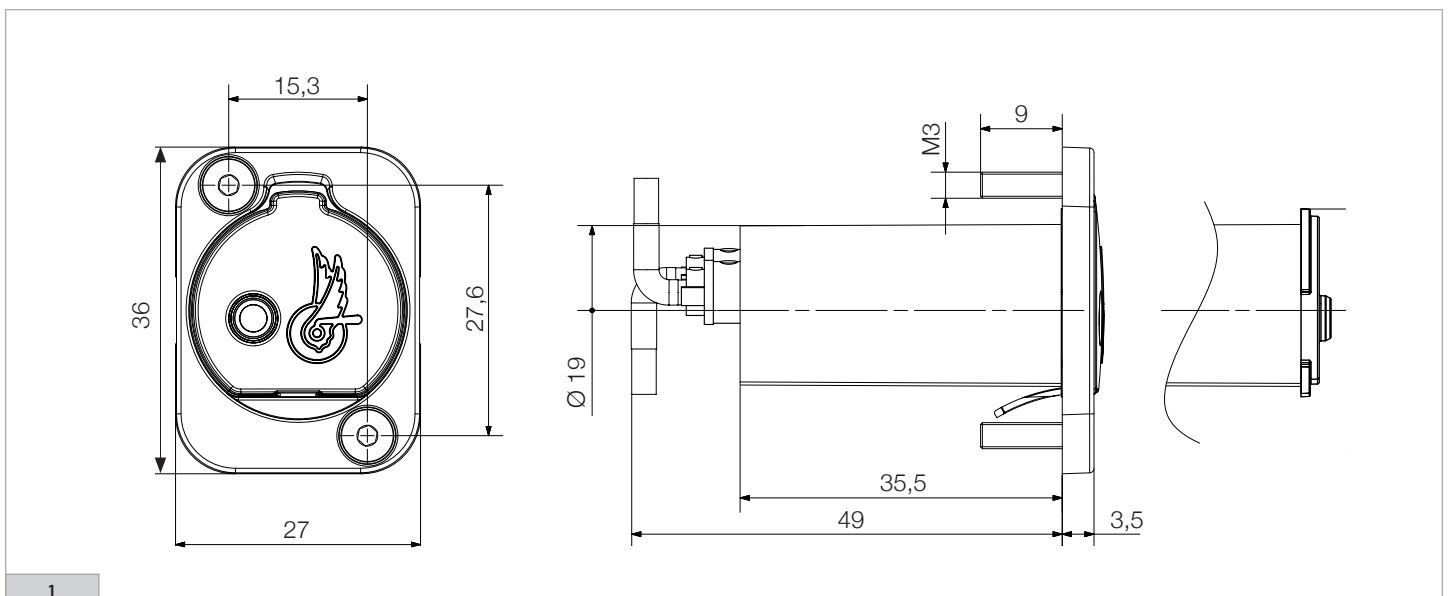

Note: where not specified, all measurements are expressed in millimetres.

2.2 - SPECIFICATIONS FOR HANDLEBAR INSTALLATION

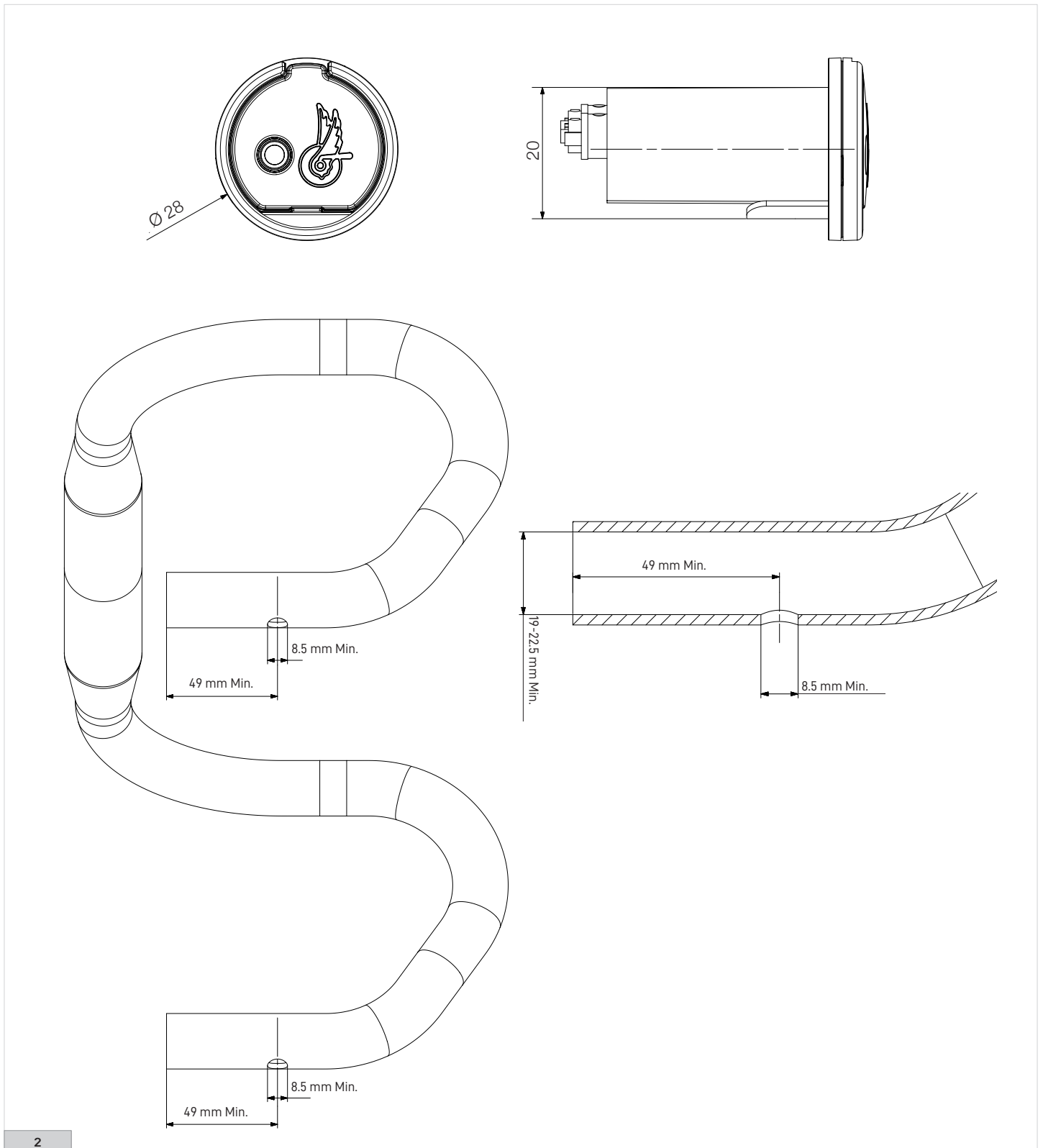

2

If the internal V4 interface is installed inside the handlebar, the latter must comply with the following specifications:

- 1) Inner diameter of the handlebar, right-hand side, with a length from the edge of 49 mm min.: 19 - 22.5 mm (Fig.2)
- 2) Presence of two holes to enable the connectors (which are to be connected to the controls and the power unit) to come out of the handlebar: specifications regarding the size of the holes and their position (Fig.2).
- 3) There must be a hole inside the handlebar with a minimum diameter of 8 mm along its entire length. This is used to pass the connector and the corresponding wiring to be connected to the left-hand control from the right-hand side of the handlebar to the left, where the interface is to be positioned.

3 - INSTALLING THE INTERFACE UNIT V4

3.1 - TOOLS AND ACCESSORIES

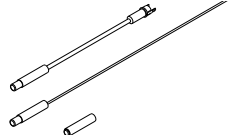
CODE	DESCRIPTION	
UT-GC010EPS	Cable guide magnet kit	

3.2 - HANDLEBAR INSTALLATION

1) Insert the long cable from the "cable guide magnet kit" into the lower left-hand hole on the handlebar (Fig.1).

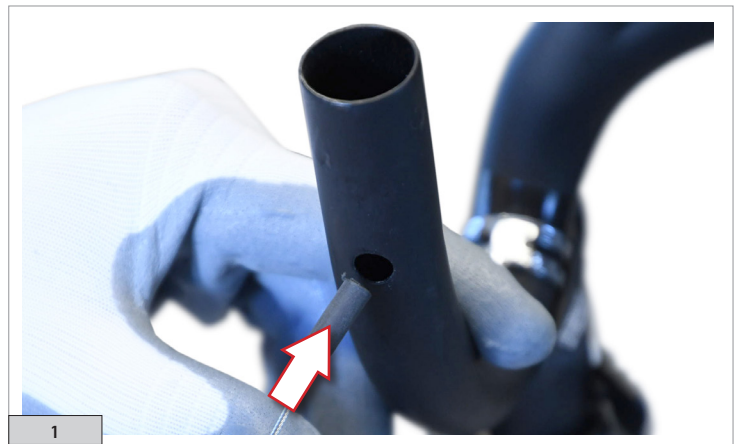

2) Bring the cable out from the right-hand side of the handlebar, using the short cable from the "cable guide magnet kit" to help if necessary (Fig. 2).

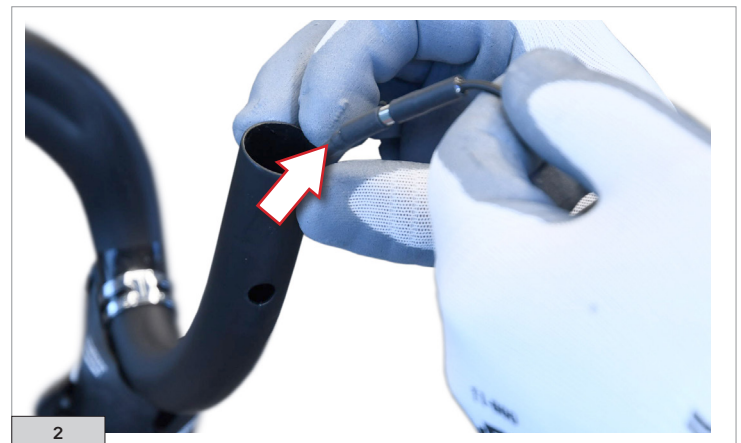

3) Connect the short cable from the "cable guide magnet kit" to the long cable, and complete the connection with the left-hand wiring connector (asymmetrical) (Fig. 3).

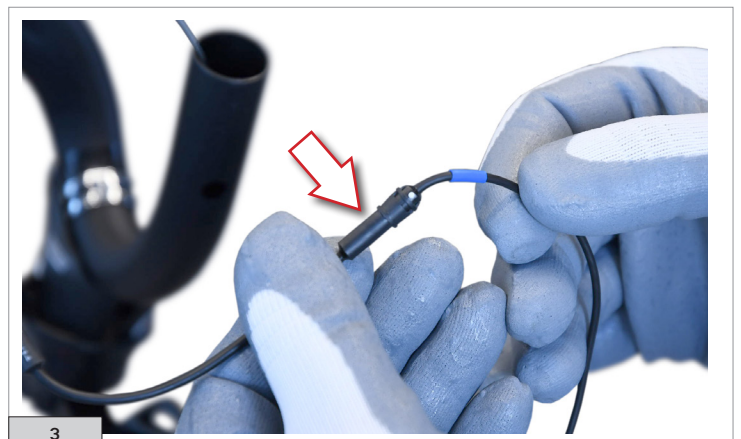

4) At this point, bring the left-hand wiring connector out from the lower left-hand hole (Fig. 4).



5) Insert the short cable from the "cable guide magnetic kit" into the lower right-hand hole on the handlebar, connect the right-hand control connector (Fig. 5) and bring it out from the same hole (Fig. 6).

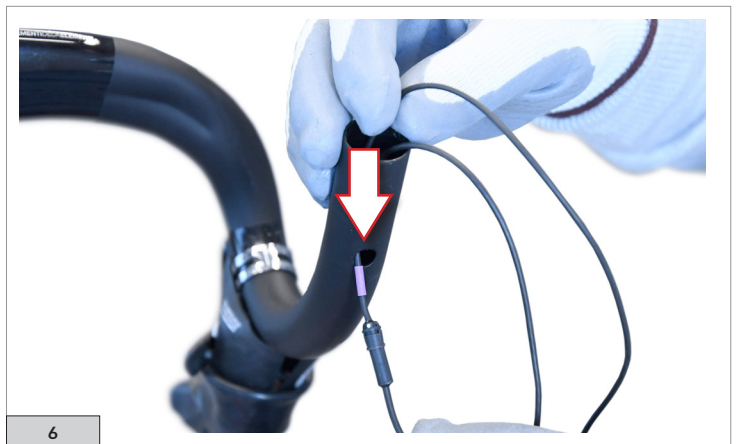
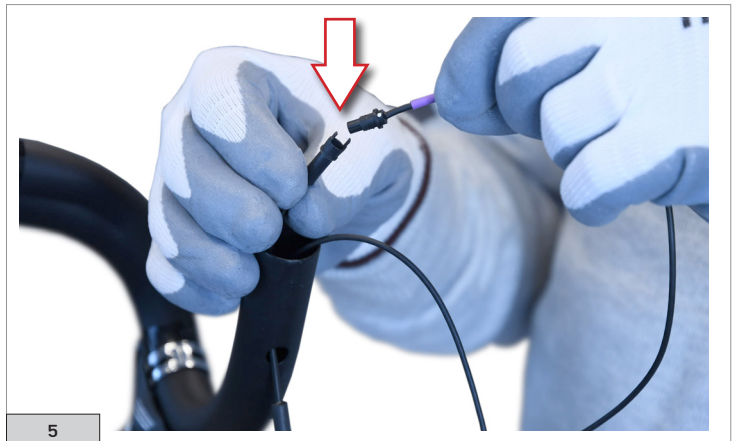

6) Insert the single connection cable to the power unit into the lower right-hand hole. (Fig. 7).

WARNING! Ensure that you have inserted the male connector.



7) Bring the single connection cable out from the right-hand side of the handlebar (Fig. 8).



8) Rest the cover (A) on the ring (B) and insert the tab (C) inside (in correspondence with the flat part of the ring) (Fig. 9).

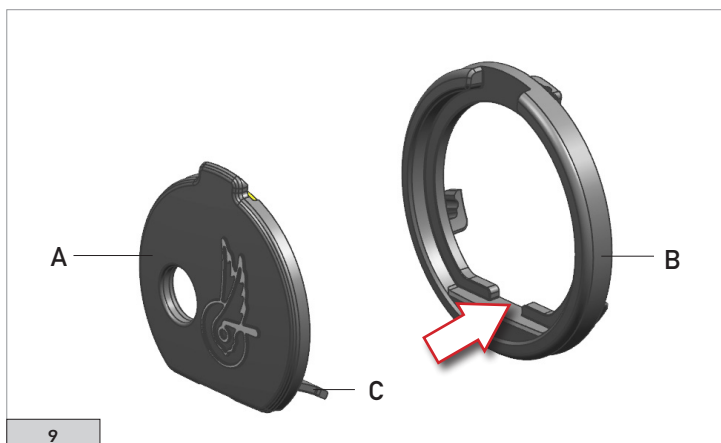

9) Move this assembly (A+B) next to the interface, insert the ring (D) from the rear side and slide it along the interface. At this point, insert the tab (C) inside the ring, in correspondence with the tab (E) (Fig. 10).

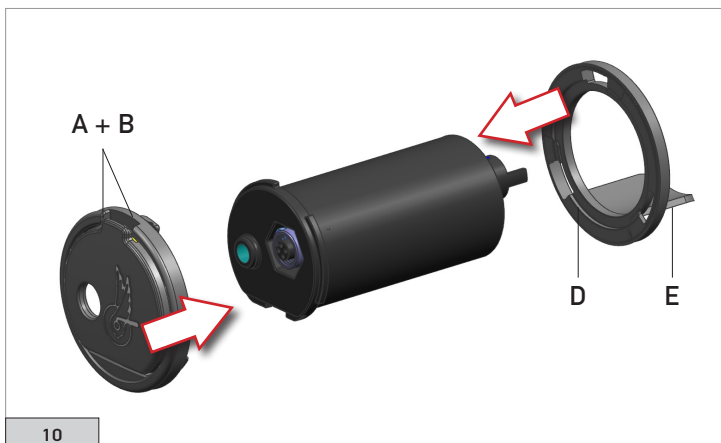

10) Line up the teeth on the ring (B) with the holes in the ring (D) and rotate the latter until the two rings (B and D) are attached to one another (Fig. 11).

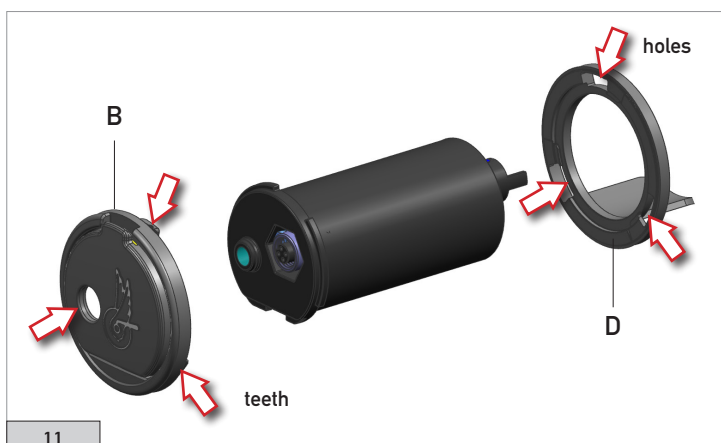

11) Connect the control connectors to the controls and position the cables on the handlebar, securing in place with the adhesive tape (Fig. 12).



12) We recommend passing the cables from the inner hole on the handlebar to the control area, along the internal surface of the handlebar (Fig. 13 - Fig. 14)

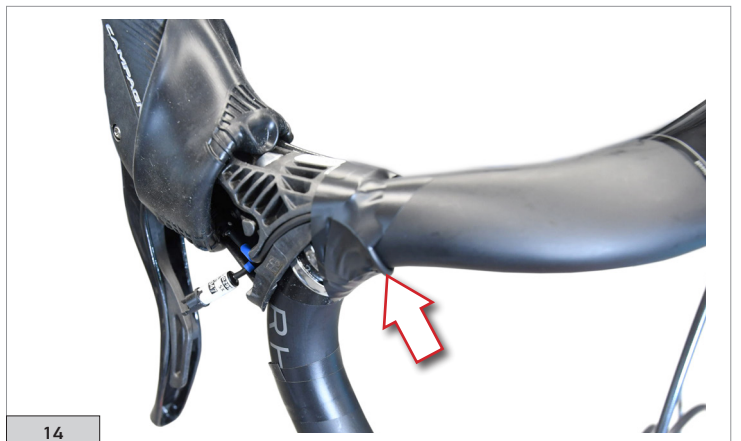

13) Apply the handlebar tape flush with the edge, without folding inwards (Fig. 15).



14) Apply the neoprene spacer on three surfaces of the interface, beginning with the flat lower surface (Fig. 16).

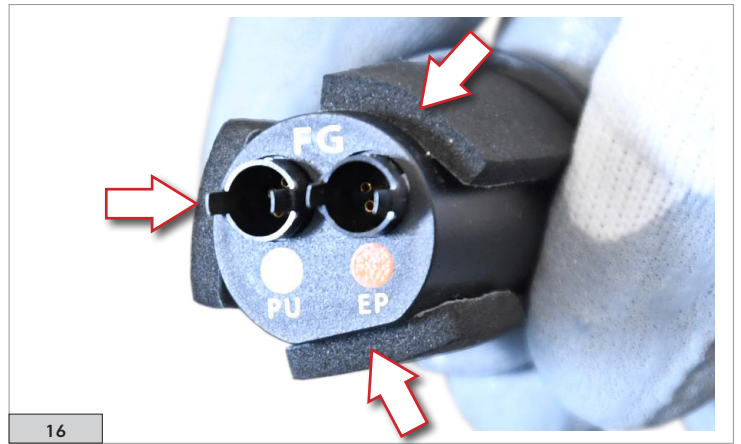

15) Insert the cable separator into the handlebar, using a non-pointed tool to help (Fig.17).

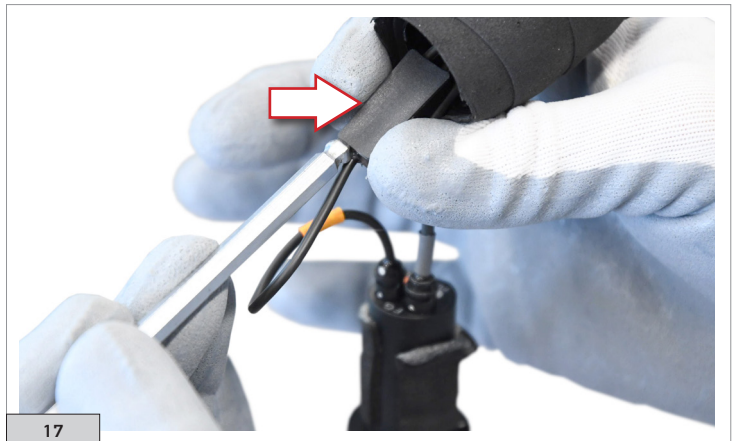

16) Connect the interface to the two cables and match the cable colours with those on the interface connectors (Fig. 18).

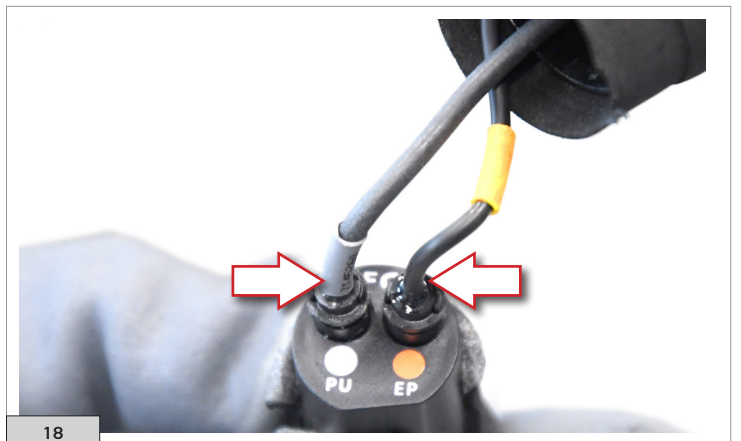

17) Insert the interface into the handlebar (Fig. 19).



18) Check that the handlebar tape allows the interface cover to be opened (Fig. 20).



3.3 - FRAME INSTALLATION

1) Remove the protective cover by unscrewing the two screws (Fig. 1).

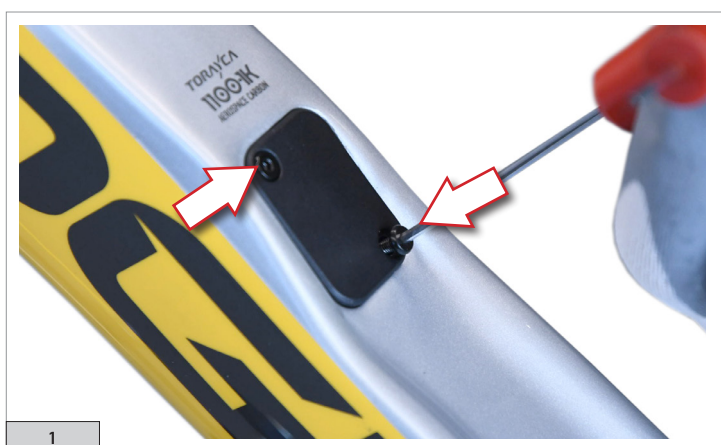

2) Insert the long cable from the "cable guide magnet kit" into the housing hole on the frame (Fig. 2).

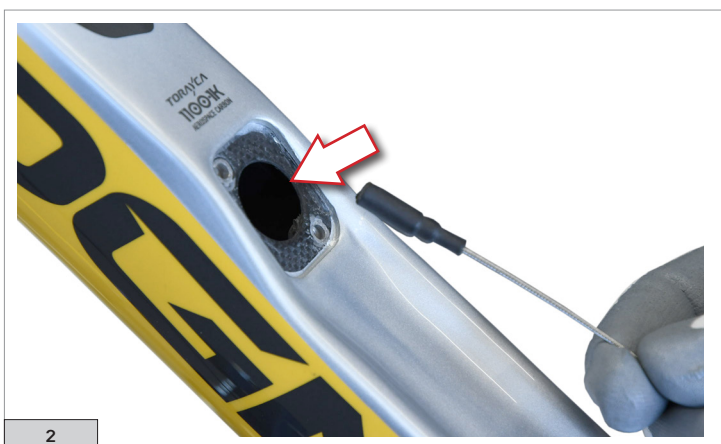

3) Bring the cable out from the hole near the handlebar, using the short cable from the "cable guide magnet kit" to help if necessary (Fig. 3).



4) Connect the orange connector to the "cable guide magnet kit" and bring it out from the frame (Fig. 4).

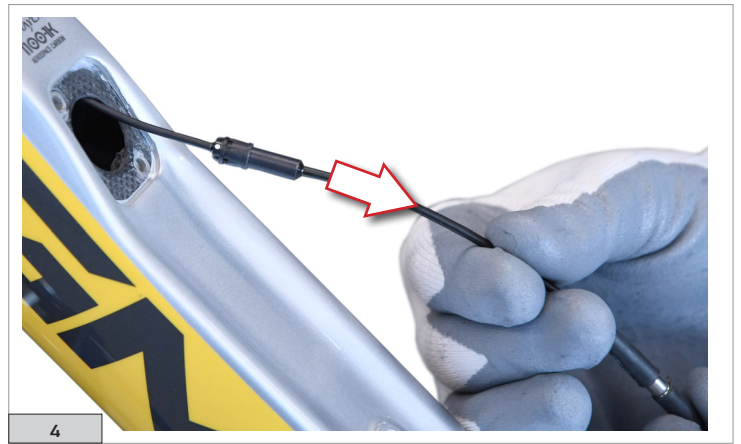

5) **Important!** The bifurcation of the connector cables for the controls must be positioned on the handlebar (Fig. 5 - Fig. 6).



6) Insert the long cable from the "cable guide magnet kit" from the interface housing hole (Fig. 7).

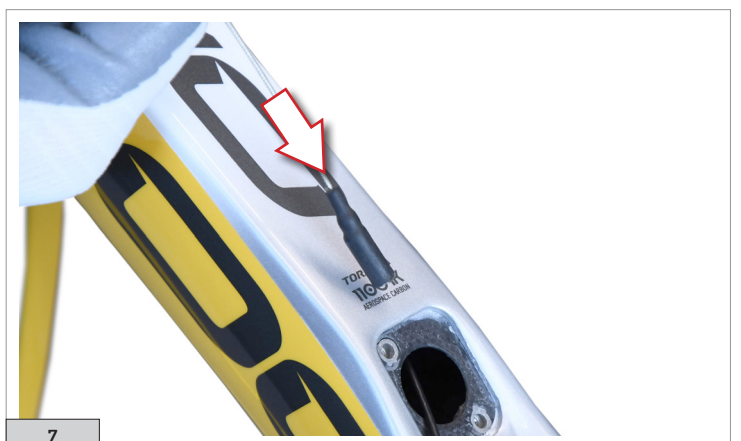

7) At this point, bring the long cable from the "cable guide magnet kit" out from the bottom bracket (Fig. 8).



8) Connect the short cable from the "cable guide magnet kit" and the grey interface cable (Fig. 9).

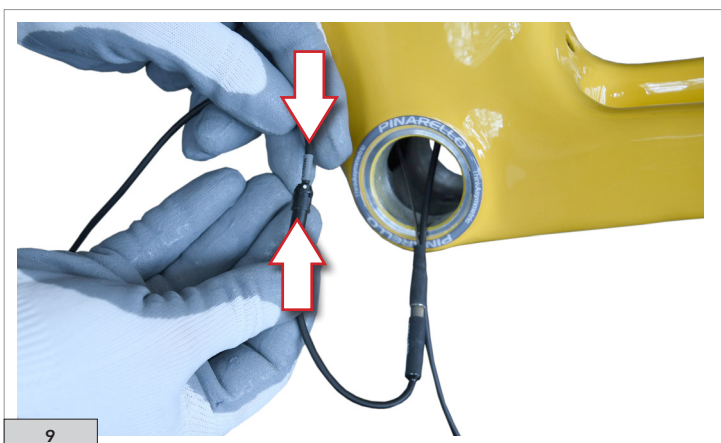

9) Bring the connector out through the interface housing hole (Fig. 10).

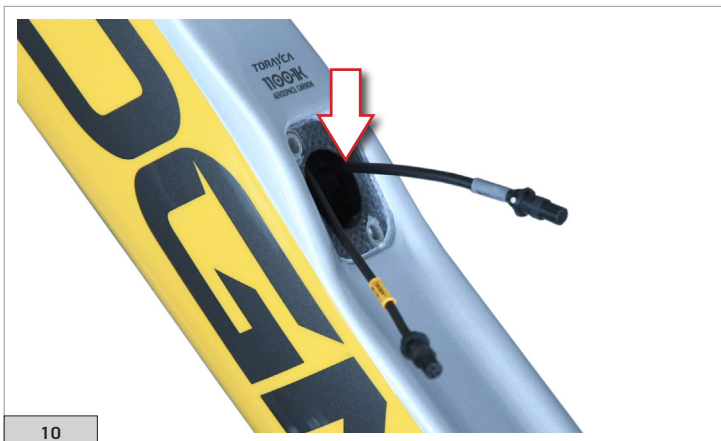

10) Insert the two male connectors into their corresponding female connectors (grey and orange); these can be found inside the interface (Fig. 11).

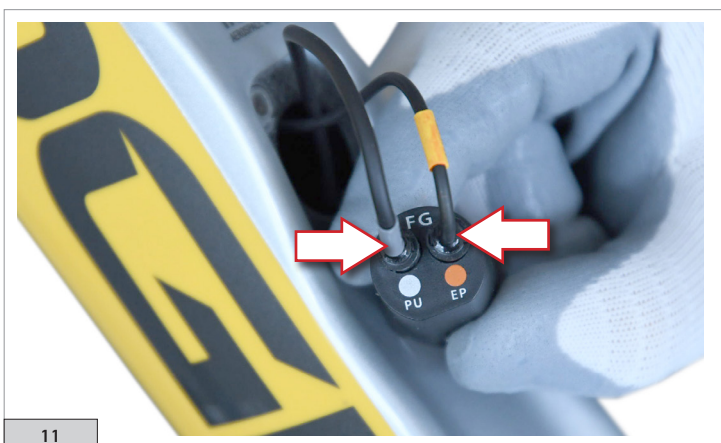

11) Insert the interface into the frame (Fig. 12).

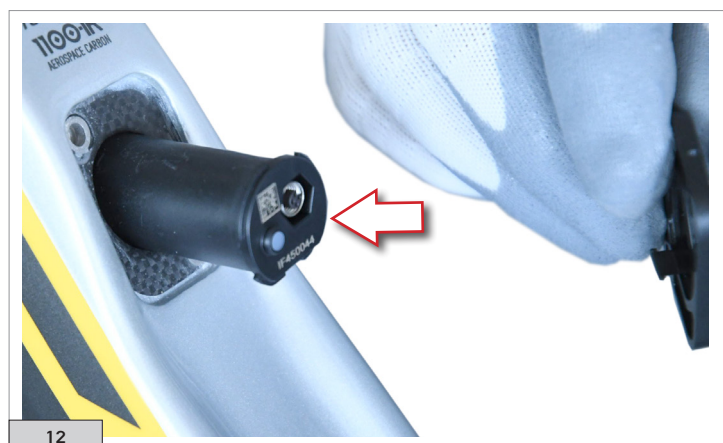

12) Rest the cover (A) on the plate (B) and insert the tab (C) inside the plate. (Fig. 13).

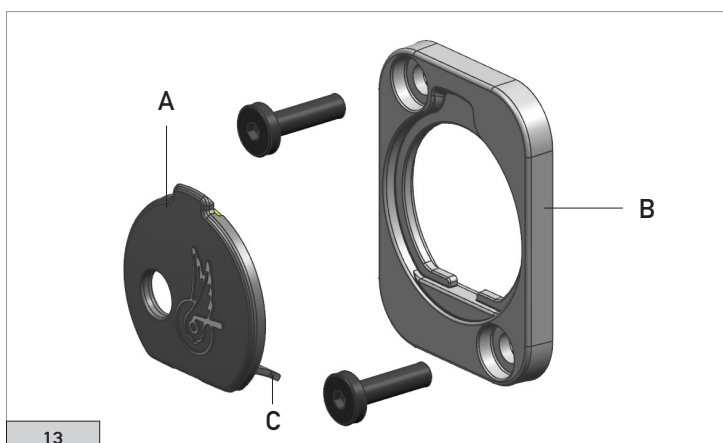

13) Rest this assembly (cover + plate) on the frame, checking that the cover tab is positioned correctly on the underside of the interface, using a screwdriver to help if necessary (Fig. 14).

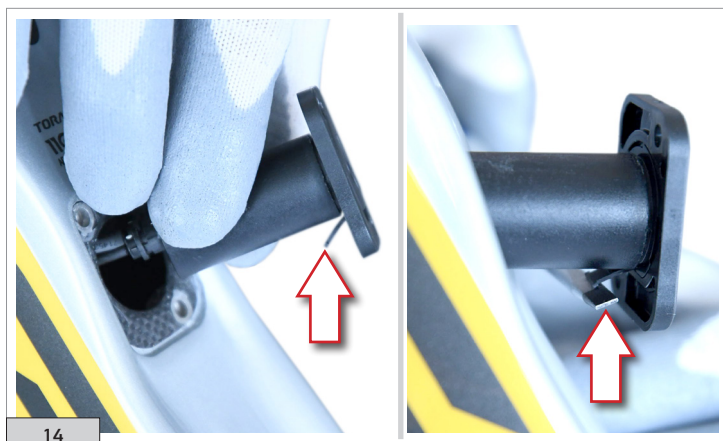

14) Fix the assembly to the frame, using the two screws provided (Fig. 15).

