

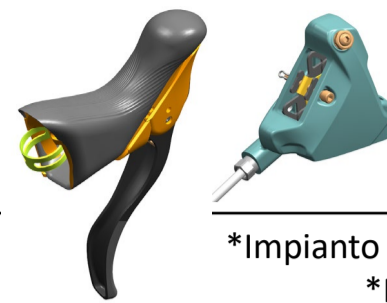

COMANDO SX + PINZA 140\*  
LEFT SHIFTER + 140 CALIPER\*

CHECK



EP25-EKGTD13L4

\*Impianto con Olio Minerale Campagnolo pre-inserito  
\*Pre-filled with **RED** Campagnolo Mineral Oil

COMANDO DX + PINZA 140\*  
RIGHT SHIFTER + 140 CALIPER\*

CHECK

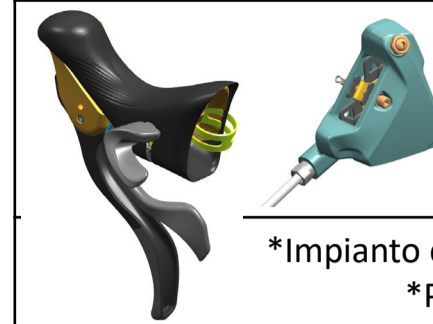

EP25-EKGTD13R4

\*Impianto con Olio Minerale Campagnolo pre-inserito  
\*Pre-filled with **RED** Campagnolo Mineral Oil

KIT RETROFIT N3W (d.30mm)

CHECK

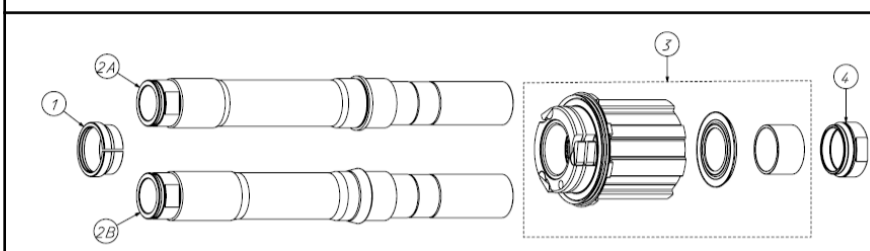

AC21-N3WR FCC

Cuscinetti / Bearings  
CONO-CALOTTA / CUP-CONE

AC21-N3WR FCS

Cuscinetti / Bearings  
INDUSTRIALI / INDUSTRIAL

CATENA / CHAIN

CHECK

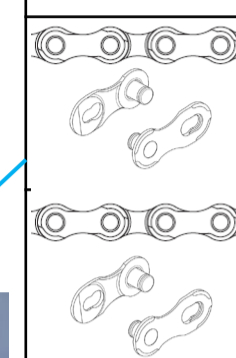

CN25-EK13ML23

13v-123  
maglie/link  
+ C-LINK

CN21-EK13ML

13v-117  
maglie/link  
+ C-LINK

DISCO POSTERIORE / REAR ROTOR

CHECK



DB-140S

DB-160S

DISCO ANTERIORE / FRONT ROTOR

CHECK



DB-140S

DB-160S

ADATTATORE POSTERIORE DA 140 A 160\*  
140 TO 160 REAR ADAPTER\*

CHECK

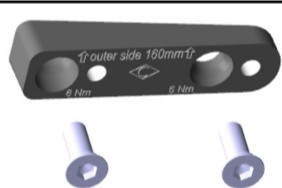

AC21-DBADR

ADATTATORE ANTERIORE DA 140 A 160\*  
140 TO 160 FRONT ADAPTER\*

CHECK

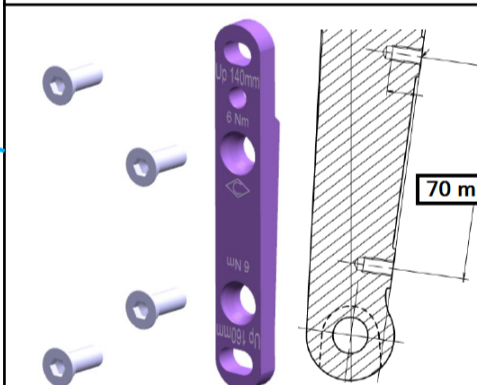

AC21-DBADF

\*Verificate la predisposizione  
del telaio come in figura  
\*Check the frame,  
as in the picture

\*Verificate il telaio, se già 160 non è necessaria la staffa  
\*Check the frame, if it's already set up for 160, the adapter is not necessary



VITE FISS. PINZA POST (2 pz) / REAR FIXING SCREWS (2 pc) CHECK

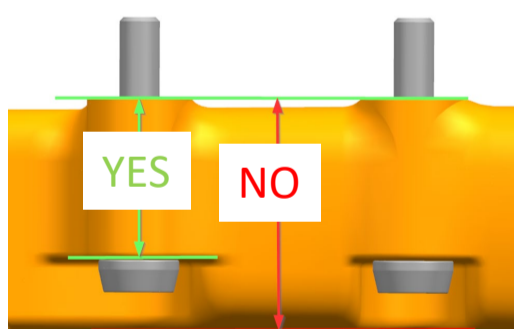

AC18-DBSC19	19mm (fodero/thickness 10-14 mm)	
AC18-DBSC24	24mm (fodero/thickness 15-19 mm)	
AC18-DBSC29	29mm (fodero/thickness 20-24 mm)	
AC18-DBSC34	34mm (fodero/thickness 25-29 mm)	
AC18-DBSC39	39mm (fodero/thickness 30-34 mm)	
AC18-DBSC44	44mm (fodero/thickness 35-39 mm)	

Misura spessore attacco pinza  
Check rear mount thickness

CASSETTA / CASSETTE 13S

CHECK

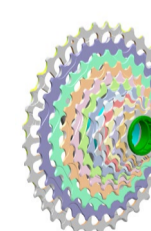

CS25-EKGT1308	10-48	
CS25-EKGT1304	10-44	
CS25-EKGT1392	9-42	
CS21-EK1396	9-36	

GUARNITURA / CRANKSET 13S

CHECK



FC25-EKGT1306	170 mm 36T	
FC25-EKGT1308	170 mm 38T	
FC25-EKGT1300	170 mm 40T	
FC25-EKGT1302	170 mm 42T	
FC25-EKGT1304	170 mm 44T	
FC25-EKGT1326	172,5 mm 36T	
FC25-EKGT1328	172,5 mm 38T	
FC25-EKGT1320	172,5 mm 40T	
FC25-EKGT1322	172,5 mm 42T	
FC25-EKGT1324	172,5 mm 44T	
FC25-EKGT1356	175 mm 36T	
FC25-EKGT1358	175 mm 38T	
FC25-EKGT1350	165 mm 40T	
FC25-EKGT1352	165 mm 42T	
FC25-EKGT1354	165 mm 44T	

CALOTTE / BOTTOM BRACKET CUPS

CHECK

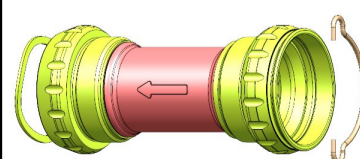

IC21-PRBB30	BB30 - PRO-TECH Press-Fit 68x42	
IC21-PRBB386	BB386 - PRO-TECH Press-Fit 86,5x46	
IC21-PRBB86	BB86 - PRO-TECH Press-Fit 86,5x41	
IC21-PRBBR	BB RIGHT - PRO-TECH Press-Fit 79x46	
IC21-PRPF30	PF30 - PRO-TECH Press-Fit 68x46	
OC21-PRG	Filettate / Threaded PRO-TECH - ING	
OC21-PRI	Filettate / Threaded PRO-TECH - ITA	
OC21-PRT4768	Filettate / Threaded PRO-TECH - T47x68	
OC21-PRT4786	Filettate / Threaded PRO-TECH - T47x86	

CAMBIO / REAR DERAILLEUR

CHECK



RD25-EKGT13